

EMC Shielding

Contents

Introduction	292
SMT Shielding Clips	294
Shielding Cans for SMT Clips	297
Development Kit	298

EMC Shielding Introduction

Industry standard types of Board Level Shielding (BLS) to prevent electromagnetic interference often involves additional expensive secondary operations that can damage circuits and components. Harwin's EMC Shielding range provides BLS without the additional expense or damage.

Existing BLS solutions require the full shield can to be soldered to the circuit board. This normally involves a secondary soldering operation, often hand-soldered and therefore expensive and slow. This can also give rise to hotspots and potential IC or track damage. In addition, if any rework or in-field replacement is required, the whole can must be de-soldered, causing more delays and expenditure.

Harwin's solution involves two separate components. The first is a SMT clip, which can be assembled in the same SMT process as the rest of the PCB components. The second is the Shield can. This is a simple five-sided construction, which quickly and easily snaps into place into the clips – no heat source and very little assembly time required. If rework or in-field service is necessary, the can be simply lifted off, and replaced once the work is completed.

- ❖ Significant decreases in manual operation times and damage potential
- ❖ Simple to use, easy to assemble, more cost effective than fence and lid can solutions
- ❖ Development kit available – make your own shield can from scored flat sheet during low-volume prototyping phases
- ❖ All SMT clips supplied on Tape and Reel for fully automated assembly at the same time as the rest of the board is populated, eliminating post-operation hotspots
- ❖ Stocked in depth throughout Harwin's authorized distributor network

SMT RFI Shield Clips

- ❖ Simple to assemble to the circuit board with conventional surface mount technologies, as the same pass as the rest of the components
- ❖ Very low profile designs, down to 0.8mm high
- ❖ Corner clip styles for options on track layouts, including an integrated corner shield cover to further minimise signal ingress/leakage and address localized eddy interference at folded can corners

Shield Cans

- ❖ Available in miniature sizes with a choice of 0.15mm, 0.2mm or 0.3mm thickness material, compatible with most of the Harwin Shield Clips
- ❖ Manufactured from Nickel Silver, ideal for high frequency shielding
- ❖ Development kit consists of two 80 x 60mm scored flat sheets, and 24 SMT Shield Clips, for prototype, pre-production or very low volume requirements

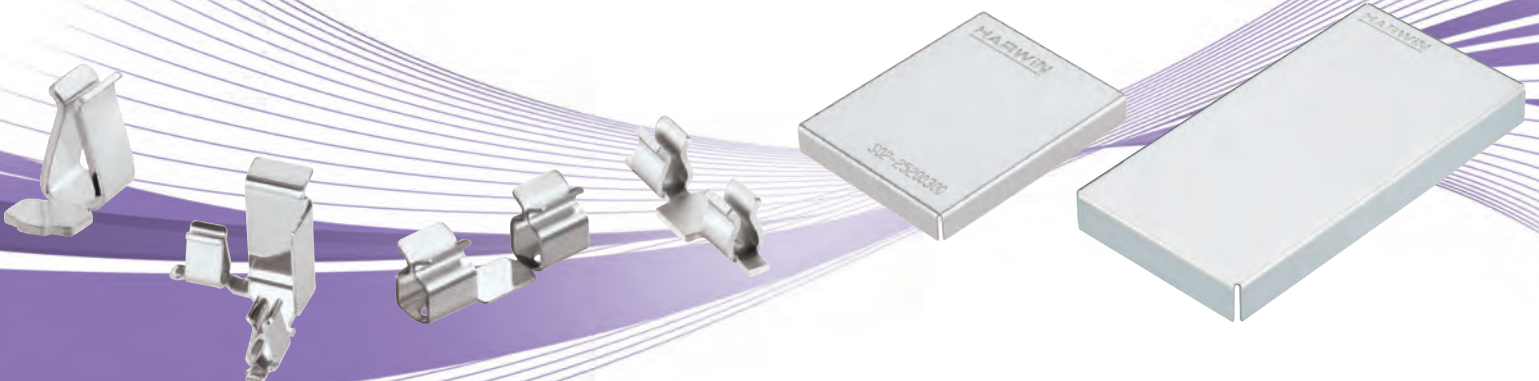

RFI Shield Clips Summary

Summary of SMT Shield Clips (further dimensional information on the following pages)

Order Code	Type	Shield Thickness	Material	Finish	Pack Qty. on Ø330mm reel	Insertion Force (max)	Withdrawal Force (min)
S1411-46R	Maxi	0.70-1.00mm	Beryllium Copper	Tin	1,900	7.0N	0.80N
S1711-46R	Midi	0.17-0.30mm	Beryllium Copper	Tin	1,900	4.0N	0.50N
S2711-46R	Midi	0.17-0.30mm	Cupro-Nickel (Beryllium-free)	Tin	1,900	4.0N	0.50N
S0971-46R	Mini	0.20-0.30mm	Stainless Steel	Tin	5,000	19.6N	0.98N
S1721-46R	Mini	0.13-0.23mm	Beryllium Copper	Tin	5,000	5.0N	0.35N
S0941-46R	Micro	0.135-0.16mm	Stainless Steel	Tin	10,000	9.8N	0.69N
S0951-46R	Micro	0.20mm	Stainless Steel	Tin	10,000	9.8N	0.69N
S0961-46R	Micro	0.15-0.20mm	Stainless Steel	Tin	10,000	24.5N	0.98N
S0991-46R	Micro	0.20-0.25mm	Stainless Steel	Tin	15,000	19.6N	0.98N
S1001-46R	Micro	0.15-0.20mm	Stainless Steel	Tin	20,000	19.6N	0.98N
S0911-46R	Compact	0.15-0.20mm	Beryllium Copper	Tin	6,500	3.0N	0.10N
S0981-46R	Corner	0.20-0.25mm	Stainless Steel	Tin	6,000	19.6N	0.98N
S0921-46R	Corner	0.30-0.40mm	Cupro-Nickel	Tin	600	15.0N	0.30N

RFI Shield Can Specifications

Materials

Material: Nickel Silver
Finish: Unplated

Packaging

S01-XXXXXXX0: Loose (Individual Bags)
S02-XXXXXXX0: Loose (Individual Bags)
S02-20150300R: Tape & Reel, 900 on a Ø330mm reel
S02-25200300R: Tape & Reel, 700 on a Ø330mm reel
S03-XXXXXXX0R: Tape & Reel, 900 on a Ø330mm reel

Compatible RFI Shield Clips

For S01-XXXXXXX0: 0.3mm thick
S1711-46R, S2711-46R, S0971-46R, S0921-46R
For S02-XXXXXXX0(R): 0.2mm thick
S1711-46R, S2711-46R, S0971-46R, S1721-46R, S0951-46R, S0961-46R, S0991-46R, S1001-46R, S0911-46R, S0981-46R
For S03-XXXXXXX0R: 0.15mm thick
S1721-46R, S0941-46R, S0961-46R, S1001-46R, S0911-46R

RFI Shield Clips

Shield Clips for EMI/RFI Shields

- ❑ SMT devices offering a fast solution for assembling RFI shields to PCBs.
- ❑ Eliminates the need for through holes and post reflow operations.
- ❑ Saves PCB real estate.
- ❑ Facilitates easy removal of the can for maintenance and repair.
- ❑ Substantial improvement in time and simplicity of assembly tuning and re-work.

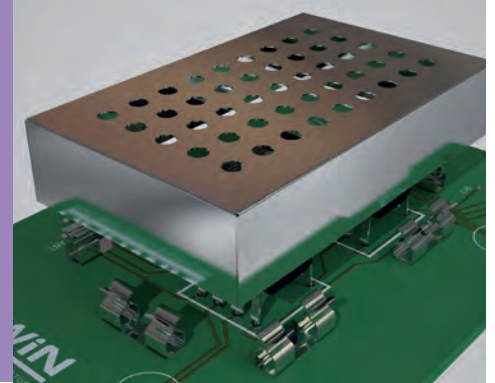

MAXI	MIDI						
<p style="text-align: right;">Shield Thickness 0.70-1.00mm</p> <p style="text-align: right;">ORDER CODE S1411-46R</p> <p style="text-align: right;">Recommended PC Board Pattern</p>	<p style="text-align: right;">Shield Thickness 0.17-0.30mm</p> <table border="1" style="width: 100%; border-collapse: collapse;"> <thead> <tr> <th style="background-color: #4a4a8a; color: white;">ORDER CODE</th> <th style="background-color: #4a4a8a; color: white;">MATERIAL</th> </tr> </thead> <tbody> <tr> <td style="background-color: #e0e0e0;">S1711-46R</td> <td style="background-color: #e0e0e0;">Beryllium Copper</td> </tr> <tr> <td style="background-color: #e0e0e0;">S2711-46R</td> <td style="background-color: #e0e0e0;">Cupro-Nickel</td> </tr> </tbody> </table> <p style="text-align: right;">Recommended PC Board Pattern</p>	ORDER CODE	MATERIAL	S1711-46R	Beryllium Copper	S2711-46R	Cupro-Nickel
ORDER CODE	MATERIAL						
S1711-46R	Beryllium Copper						
S2711-46R	Cupro-Nickel						
MINI	MINI						
<p style="text-align: right;">Shield Thickness 0.20-0.30mm</p> <p style="text-align: right;">ORDER CODE S0971-46R</p> <p style="text-align: right;">Recommended PC Board Pattern</p>	<p style="text-align: right;">Shield Thickness 0.13-0.23mm</p> <p style="text-align: right;">ORDER CODE S1721-46R</p> <p style="text-align: right;">Recommended PC Board Pattern</p>						

All dimensions in mm.

RFI Shield Clips

Shield Clips for EMI/RFI Shields

- Compatible with industry standard placement machines.
- Packaged in standard (EIA 481) Tape & Reel format.
- Spring contact design provides secure can retention.
- Higher force options for retention under vibration.

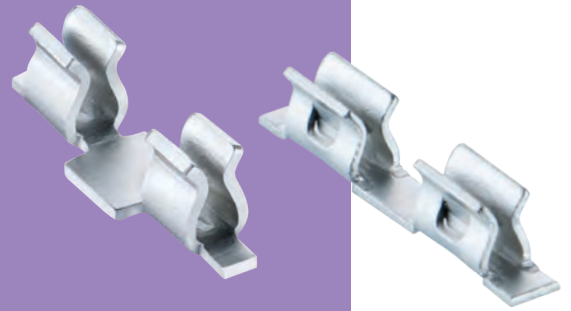

<p>MICRO</p> <p>Shield Thickness 0.135-0.16mm</p> <p>ORDER CODE S0941-46R</p>	<p>MICRO</p> <p>Shield Thickness 0.20mm</p> <p>ORDER CODE S0951-46R</p>
<p>MICRO</p> <p>Shield Thickness 0.15-0.20mm</p> <p>ORDER CODE S0961-46R</p>	<p>MICRO</p> <p>Shield Thickness 0.20-0.25mm</p> <p>ORDER CODE S0991-46R</p>

All dimensions in mm.

RFI Shield Clips

Shield Clips for EMI/RFI Shields

- ❖ Compatible with industry standard placement machines.
- ❖ Packaged in standard (EIA 481) Tape & Reel format.
- ❖ Spring contact design provides secure retention.
- ❖ Ideally suited to miniature electronics.
- ❖ Low profile and corner clips offer design flexibility.

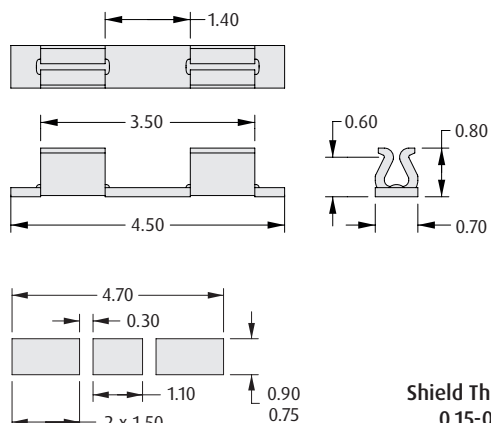
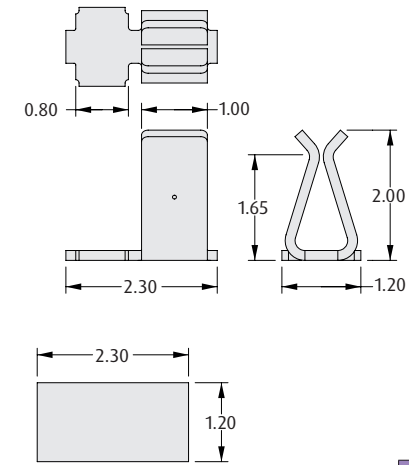
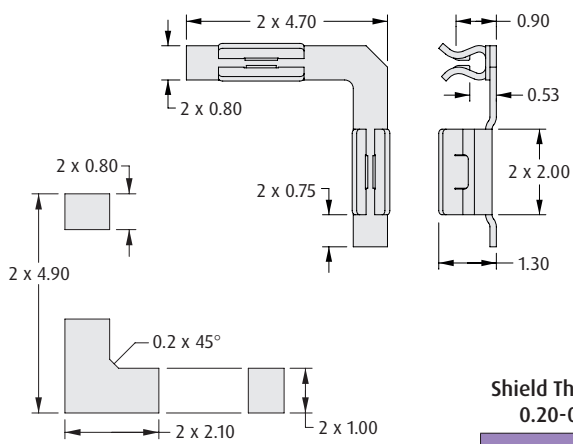
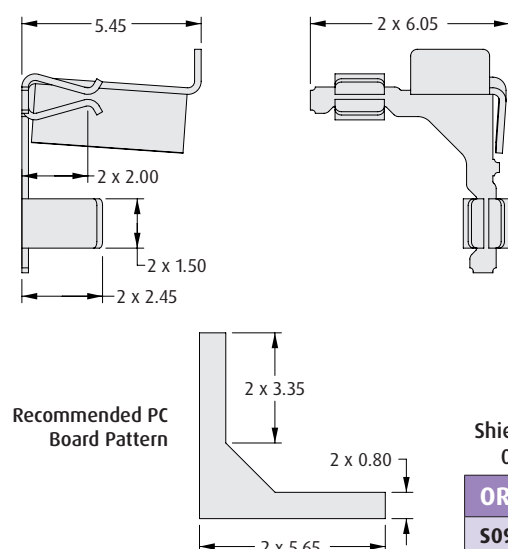

MICRO	COMPACT
 <p style="text-align: right;">Shield Thickness 0.15-0.20mm</p> <p style="text-align: center;">ORDER CODE S1001-46R</p> <p style="text-align: center;">Recommended PC Board Pattern</p>	 <p style="text-align: right;">Shield Thickness 0.15-0.20mm</p> <p style="text-align: center;">ORDER CODE S0911-46R</p> <p style="text-align: center;">Recommended PC Board Pattern</p>
CORNER	CORNER
 <p style="text-align: right;">Shield Thickness 0.20-0.25mm</p> <p style="text-align: center;">ORDER CODE S0981-46R</p> <p style="text-align: center;">Recommended PC Board Pattern</p>	 <p style="text-align: right;">Shield Thickness 0.30-0.40mm</p> <p style="text-align: center;">ORDER CODE S0921-46R</p> <p style="text-align: center;">Recommended PC Board Pattern</p>

All dimensions in mm.

RFI Shield Cans

EMI/RFI Shielding

- Provides excellent RFI and EMI protection to sensitive circuitry at the PCB level.
- Standard can sizes available from stock.

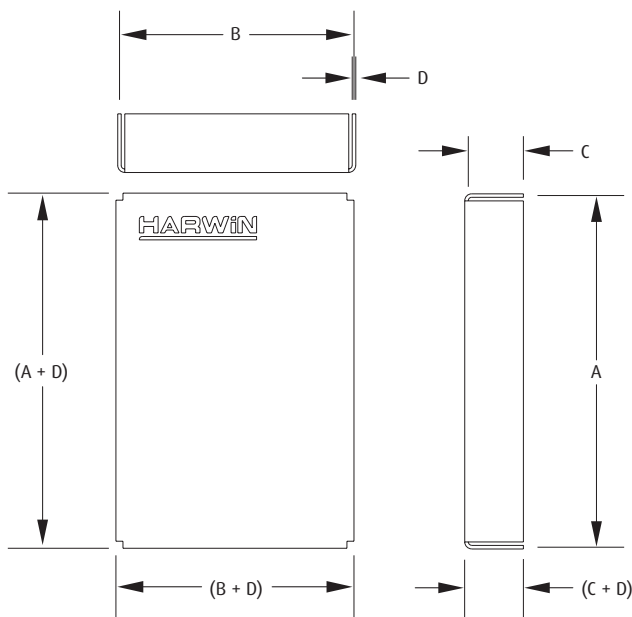
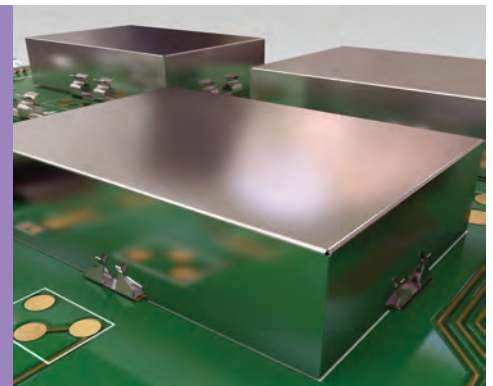

ORDER CODE	DIM A	DIM B	DIM C	DIM D
S01-30200500	30mm	20mm	5mm	0.3mm
S01-30300500	30mm	30mm	5mm	0.3mm
S01-50250500	50mm	25mm	5mm	0.3mm
S02-20150300(R)	20mm	15mm	3mm	0.2mm
S02-25200300(R)	25mm	20mm	3mm	0.2mm
S02-30200250	30mm	20mm	2.5mm	0.2mm
S03-10100300R	10mm	10mm	3mm	0.15mm
S03-15100300R	15mm	10mm	3mm	0.15mm
S03-30100300R	30mm	10mm	3mm	0.15mm

- Dimensions A and B are measured from the **CENTER** of the material thickness.
- Dimension C is measured from the bottom edge to the **INSIDE** of the top face.

HOW TO ORDER

S0X - XX XX XXX 0 X

SERIES CODE	
S01	Thickness (Dim D) = 0.3mm
S02	Thickness (Dim D) = 0.2mm
S03	Thickness (Dim D) = 0.15mm

DIMENSION A
Example: 30mm = 30

PACKAGING	
Blank	Loose (S01, S02)
R	Tape & Reeled (S02, S03)

FINISH	
0	Unplated

DIMENSION C
Example: 5mm = 050

DIMENSION B
Example: 30mm = 30

All dimensions in mm.

RFI Shield Can Kit

SMT Clips and Make-Your-Own Cans

- ❖ Make your own Shield Cans in minutes, ideal for fast prototyping.
- ❖ Kit contains DIY Shield Can blanks, Shield retention clips and full instructions.
- ❖ Nickel Silver material for effective & useable shielding (frequency/configuration dependent).
- ❖ Shield Can is removable for adjustment.

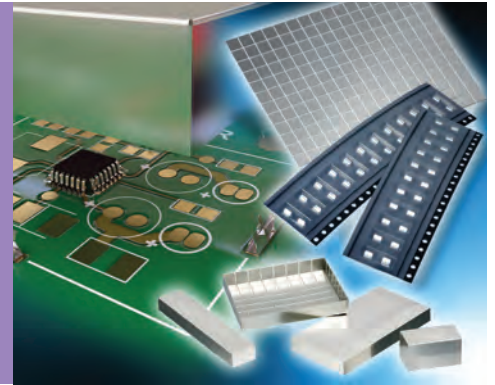

SHIELD CAN KIT

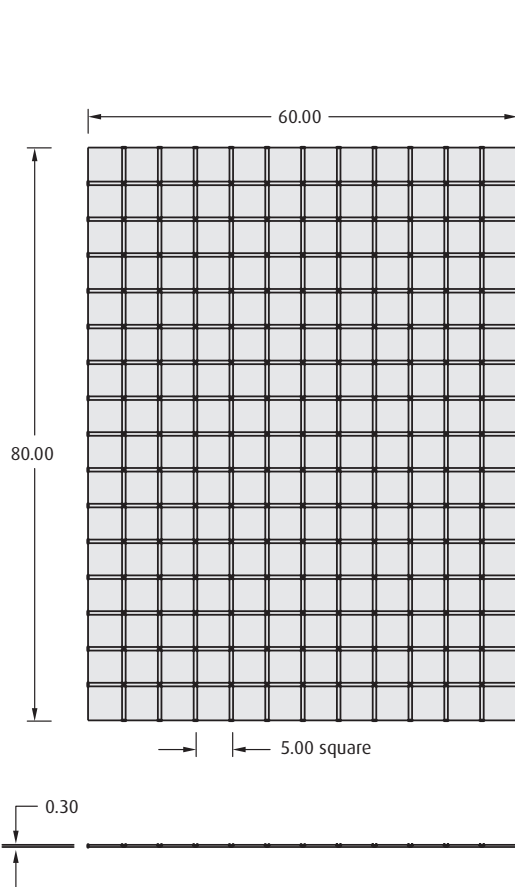

2 x Shield Can Sheets
5mm pitch score lines, for folding

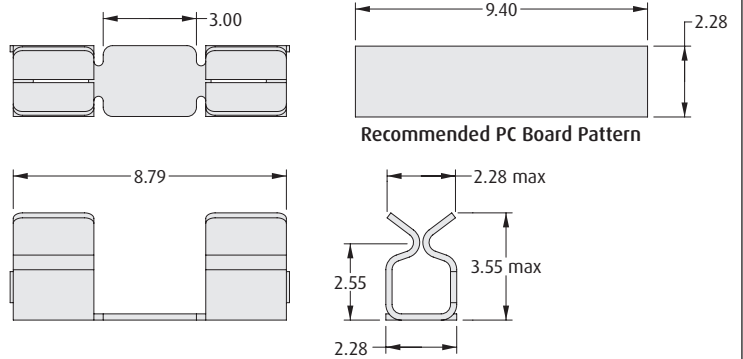

24 x Shield Clip S1711-46R



Instruction Sheet
(available from www.harwin.com/instructions)

ORDER CODE
S01-806005KIT

All dimensions in mm.